

FLIR T1030sc

HD THERMAL IMAGING FOR R&D APPLICATIONS

HD PERFORMANCE IN A PORTABLE,
HANDHELD INFRARED CAMERA



1024 x 768 HD

INTRODUCING THE FLIR T1030sc

OUTSTANDING HD INFRARED PERFORMANCE, BUILT ON 50 YEARS OF EXPERIENCE

Born out of five decades of infrared expertise, the FLIR T1030sc is designed for engineers, researchers, and scientists who need exceptional resolution and thermal sensitivity in a flexible, battery-powered, handheld package.

The T1030sc is a high-speed imaging and measurement camera that records 1024 x 768 HD resolution images at 30 frames per second. Stream lossless HD data at 120 Hz via the high-speed interface (HSI), or capture windowed areas at up to 480 Hz. The camera offers a thermal sensitivity of < 20 mK (NETD) and wide temperature ranges with calibrations up to 2000°C.

The T1030sc system includes FLIR OSX™ Precision HDIR optics, featuring an ultrasonic drive, ambient temperature drift compensation, and parasitic radiation protection. View, acquire, analyze, and share the imagery in FLIR's ResearchIR Max or with MathWorks® MATLAB. For even more flexibility, integrate data into your own enterprise platform through ATLAS SDK.

EXPERT FEATURES FOR EXPERT NEEDS:

- High definition LWIR imagery from an uncooled, portable system
- Thermal sensitivity that's 2.5 times better than industry standard
- Battery-powered, handheld camera goes where you need it
- Records high-speed radiometric video, up to 480 Hz with windowing
- Control and analyze directly from included FLIR ResearchIR Max or 3rd party software
- Wide temperature range for capturing dynamic thermal events
- Never miss a hot spot – record continuous radiometric video
- Customized functionality to fit your expert needs



FLIR 2-5-10 WARRANTY

The T1030sc is covered by our revolutionary FLIR 2-5-10 Warranty when registered within 60 days of purchase.

- 2 Years on camera parts and labor
 - 5 Years on Li-Ion batteries
 - 10 Years on the IR detector

Only FLIR can provide peace of mind like this, because only FLIR makes its critical camera components from the ground up.

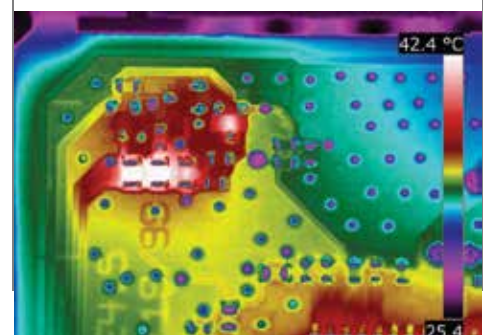
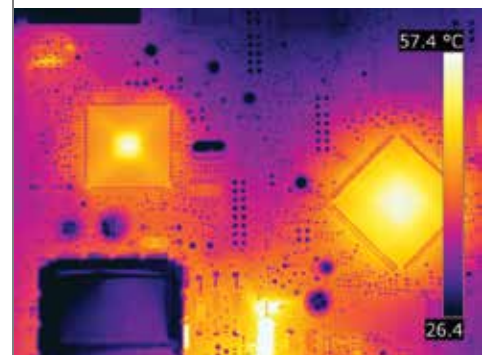
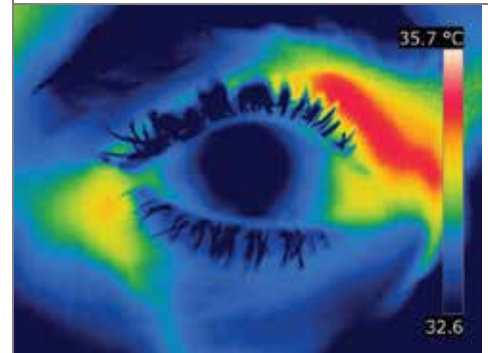

HIGH DEFINITION, HIGH SENSITIVITY THERMAL IMAGING FROM A FLEXIBLE, BATTERY-OPERATED, HANDHELD CAMERA

T1030 KEY FEATURES



OUTSTANDING IMAGE QUALITY
1024 x 768 LWIR detector offers high resolution and exceptional thermal sensitivity

FLIR VISION PROCESSOR™
MSX®, UltraMax™, and adaptive filtering algorithms ensure the sharpest, most detailed images with the least noise

WIDE TEMPERATURE RANGE
Temperature calibrations up to 2000°C, allowing for the capture of dynamic thermal events

PORTABLE, HANDHELD, AND BATTERY-POWERED
This science unit is easy to take and use wherever you need it, whether that's in a research lab or out in the field

CONFIGURABLE TO YOUR NEEDS
Four programmable buttons, rotating optical block, optional microscope mount, and more help conform this camera to your research needs



AVOID GLARE IN BRIGHT SURROUNDINGS
High resolution viewfinder with glare reducing eyecup makes scanning easier outside the lab

STREAM OR RECORD RADIOMETRIC VIDEO
Store real-time HD radiometric data in the camera or stream at up to 120 Hz (480 Hz with windowing)

FLIR OSX™ PRECISION HDIR OPTICAL SYSTEM
Provides high-fidelity imagery and accurate temperature measurements, from the telephoto to the microscopic lens

WIRELESS CONTROL AND DATA SHARING
Wi-fi communication simplifies image sharing, remote control and viewing, and quick reporting from the field

OUTSTANDING IMAGE CLARITY; EXCEPTIONAL PRECISION OPTICS; PORTA

ULTRAMAX™

FLIR's UltraMax is a unique processing technique that allows you to generate reports with images that have up to four times as many pixels and 50% less noise than standard native images. More pixel coverage with UltraMax helps fill in inactive gaps, producing denser temperature measurements for greater thermal accuracy from even farther away.

OPTIMAL ERGONOMICS:

- Rotating optical block puts any target in comfortable viewing range
- Target and scan in bright daylight with high-resolution viewfinder
- Dynamic focus control adjusts to your touch
- Designed to be comfortable in your hand for long-term use

EASE OF USE:

- Highly responsive touch screen makes menu navigation easy
- Wi-Fi for image sharing & remote control via smart devices
- Voice, text, or sketch annotations add important detail to images

PORTABILITY, FLEXIBILITY:

- Full recording functionality under battery power
- On-camera measurement tools and analytics
- Programmable buttons and measurement functions

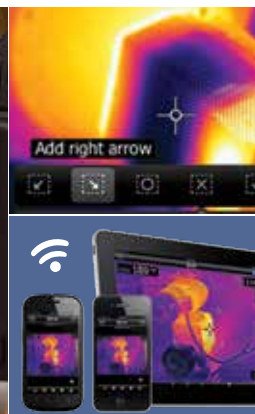
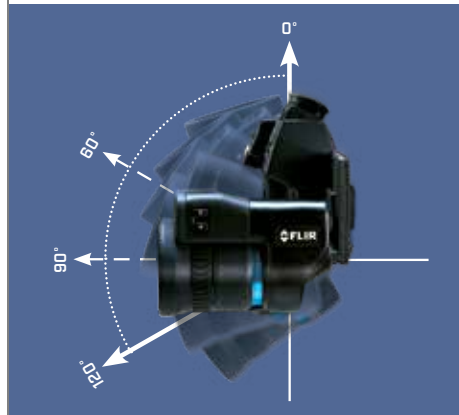
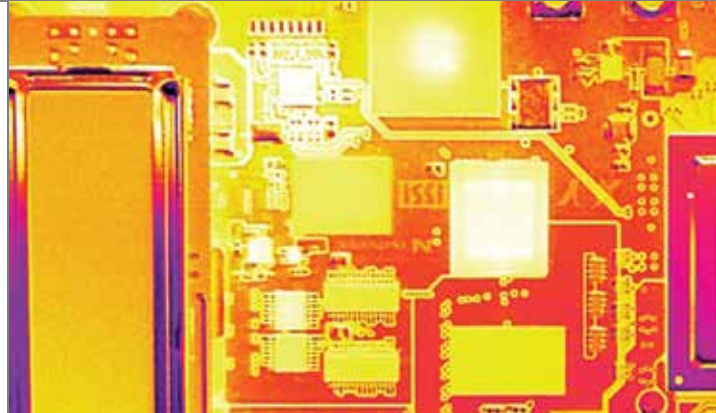

BLE, ERGONOMIC DESIGN – THE INNOVATIONS YOU’VE ALWAYS WANTED



HIGH PERFORMANCE LENSES:

- Lenses designed specifically for use with HD detectors
- Integrated temperature sensors for accurate measurements
- Interchangeable zoom and microscope lenses
- Responsive ultrasonic focus drive



INTEGRATION AND COMMUNICATION:

- Stream high-speed data through FLIR High-Speed Interface (HSI)
- Control camera and share data from FLIR ResearchIR Max
- Integrate with your enterprise software through ATLAS SDK
- Control camera and stream directly to MathWorks® MATLAB

STREAMLINED DATA CAPTURE AND ANALYSIS

FLIR ResearchIR Max is a powerful thermal analysis software tool for FLIR R&D / Science cameras. It provides camera control, high-speed data recording, image analysis, and data sharing.

This software connects directly with the T1030sc and supports multiple acquisition options, including high-speed burst recording and slow-speed data logging. This software is highly customizable, with the ability to set everything from the number of frames acquired to the thermographic and radiometric calibrations.

ResearchIR Max offers real-time image analysis with spots, lines, and other measurement tools. This software’s charting and plotting capabilities include line profiles, histograms, and temporal plots for all measurement tools.

For even greater flexibility, FLIR thermal imaging cameras work seamlessly together with standard R&D software programs such as MathWorks® MATLAB. You can access MATLAB scripts directly from ResearchIR for customized thermal analyses and processing. Create plots and reports, or process data as MATLAB code. MATLAB offers object detection and tracking, as well as thermal image enhancements such as filtering, segmentation, and statistics.

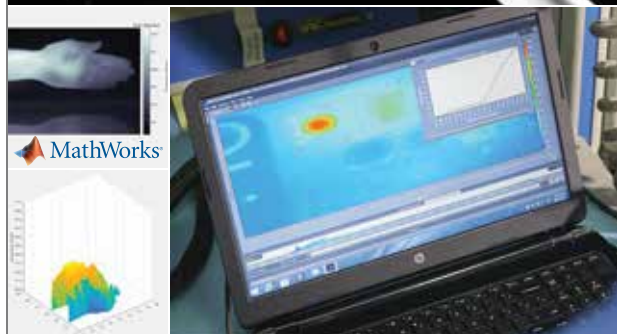

SPECIFICATIONS

Model Number	FLIR T1030sc
Imaging and Optical Data	
IR Sensor	1024 × 768 pixels
Thermal Sensitivity/NETD	< 20 mK at +30°C (+86°F)
Lens Choices	12°, 28°, 45°, 50 µm Close-up
Minimum Focus Distance	0.4 m (standard lens)
Spatial Resolution/IFOV	0.47 mrad (standard lens)
Focus	Auto, continuous auto, manual
Digital Zoom	1-8x continuous
Detector Type	Focal Plane Array (FPA), uncooled microbolometer
Spectral Range	7.5 - 14 µm
Detector Pitch	17 µm
Display	4.3 in., 800 x 480 pixel capacitive touch screen
Auto Orientation	Automatic landscape or portrait
Viewfinder	Built-in; 800 x 480 pixels
Image Presentation Modes	
Thermal Image	Full color IR image
Visual Image	Full color digital image
MSX®	Embosses visual details onto the full resolution thermal image, providing perspective and allowing you to read labels
UltraMax™	Unique super-resolution process quadruples pixel count, up to 3.1 MP
Measurement	
Object temp. range	+100°C to +650°C (+212°F to +1202°F) -40°C to +150°C (-40°F to +302°F) +300°C to +2000°C (+572°F to +3632°F)
Accuracy	±1°C (±1.8°F) or ±1% at 25°C for temperatures between 5°C to 150°C. ±2°C (±3.6°F) or ±2% of reading at 25°C for temperatures up to 1200°C
Measurement Analysis	
Measurement Tools	10 spotmeters, 5+5 areas (boxes, circles) with max./min./average
Measurement Presets	No measurements, center spot, hot spot, cold spot, User Preset 1, User Preset 2
Emissivity Correction	Variable from 0.01 to 1.0 or selected from materials list
Measurements Correction	Emissivity, reflected temperature, relative humidity, atmospheric temperature, object distance, external IR window compensation
Automatic Gain Control	Manual, Linear, Histogram
Color Palettes	Iron, Rainbow, Rainbow HC, White hot, Black hot, Arctic, Lava
Color Alarm (Isotherm)	Above/below/interval
Measurement Function Alarm	Audible/visual alarms (above/below) on any selected measurement function
Storage of Media	
Storage Media	Removable SD card (Class 10)
Image Storage	Standard JPEG, including digital photo and measurement data
Time Lapse	15 seconds to 24 hours
File Formats	Standard JPEG, measurement data included CSQ, measurement data included
Video Recording/Streaming	
Time Constant	< 10 ms
Frame Rate	30 Hz, full window, in camera 120 Hz, full window, with HSI to computer 480 Hz, ¼ window with HSI
Radiometric IR-Video Recording	Real-time radiometric recording to SD card
Non-Radiometric IR-Video Recording	H.264 to SD card
Radiometric IR-Video Streaming	Real-time radiometric streaming via USB
Non-Radiometric IR-Video Streaming	H.264 video using Wi-Fi or USB

Digital Camera			
Digital Camera	Field of View Match: adapts to the IR lens		
Video Lamp	Built-in LED light		
Image Annotations			
Voice	60 sec (via Bluetooth) stored with the image		
Text	Add table. Select between predefined templates		
Image Description	Short note stored in JPEG exif tag		
Sketch	Draw on thermal/digital photo or add predefined stamps Separate PC software with extensive report generation		
Additional Information			
GPS, Compass	Location data, camera direction automatically added to every image		
Laser Pointer	Dedicated button, position is automatically displayed on IR image		
Interfaces	USB-micro-AB, Bluetooth, Wi-Fi, HDMI		
USB, Connector Type	USB Micro-B Data transfer to and from PC Uncompressed colorized video		
Battery	Rechargeable Li-ion polymer battery		
Battery Operating Time	> 2.5 hours at 25°C (+68°F)		
Charging System	In camera (AC adapter or 12 V from a vehicle) or 2-bay charger		
Charging Time	2.5 hours to 90% capacity		
External Power Operation	AC adapter, 90-260 VAC input, 50/60 Hz or 12 V output from a vehicle (cable with standard plug, optional)		
Power Management	Automatic power-off functionality, user-configurable		
Storage Temp. Range	-40°C to +70°C (-40 to 158°F)		
Weight	1.9 kg (4.3 lb.) to 2.1 kg (4.6 lb.), depending upon lens model		
Tripod Mounting	UNC ¼"-20		
System Includes:			
Infrared camera with lens	FLIR ResearchIR Max	SD card	HSI box
Battery (2 each)	Hard transport case	Neck strap	Calibration certificate
Battery charger	Large eyecup	Power supply, including multi-plugs	FLIR Tools download card
HDMI-HDMI cable	Lens cap	USB cable, Standard A to Mini-B	User documentation on CD-ROM
	Bluetooth headset		Printed documentation

TRAINING SUPPORT

SUPPORT FROM ITC

The mission of the Infrared Training Center is to make our customers and partners successful by enhancing their knowledge of IR technology, thermal imaging products, and relevant applications.

At ITC, you can take initial training courses in thermography, or receive more advanced training specific to research and development. All of our instructors are experienced thermal imaging specialists who have practical experience with numerous applications.

More information is available at www.infraredtraining.com



NASHUA
FLIR Systems, Inc.
9 Townsend West
Nashua, NH 03063
USA
PH: +1 603.324.7600

PORTLAND
[Corporate Headquarters](#)
FLIR Systems, Inc.
27700 SW Parkway Ave.
Wilsonville, OR 97070
USA
PH: +1 503.498.3547

CANADA
FLIR Systems, Ltd.
920 Sheldon Court
Burlington, ON L7L 5L6
Canada
PH: +1 800.613.0507

UK
FLIR Systems UK
2 Kings Hill Avenue
Kings Hill
West Malling - Kent
ME19 4AQ
United Kingdom
PH: +44 (0)1732 220 011

EUROPE
FLIR Systems
Luxemburgstraat 2
2321 Meer
Belgium
PH: +32 (0) 3665 5100

SWEDEN
FLIR Systems AB
Antennvägen 6,
PO Box 7376
SE-187 66 Täby
Sweden
PH: +46 (0)8 753 25 00

LATIN AMERICA
FLIR Systems Brasil
Av. Antonio Bardella, 320
Sorocaba, SP 18052-852
Brasil
TEL: +55 15 3238 7080

HONG KONG
FLIR Systems Co., Ltd
Rm 1613-16, Tower II
Grand Central Plaza
138 Shatin Rural
Committee Road Shatin,
New Territories
Hong Kong
TEL: +852 2792 8955

www.flir.com/research
NASDAQ: FLIR

Equipment described herein may require US Government authorization for export purposes. Diversion contrary to US law is prohibited. Specifications are subject to change without notice.

For the most up-to-date specs, visit our website: www.flir.com/T1030sc. ©2015 FLIR Systems, Inc. All other brand and product names are trademarks of FLIR Systems, Incorporated. Imagery used for illustration purposes only. 11/2015